

# OMBRA CLOCK WALL

Assembly instructions  
Instrucciones de montaje



Escanear el código QR para acceder al vídeo de montaje.  
Scan the QR code to get access to the assembly video.

1

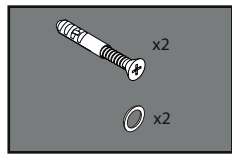
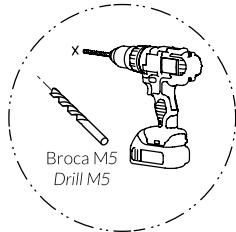
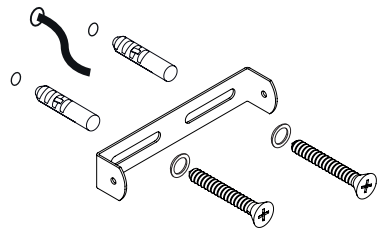

2



Use the template to mark where the clock anchor will be drilled.

Marcar con la plantilla el punto donde se roscara el anclaje del reloj.

3

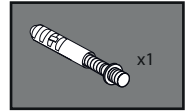
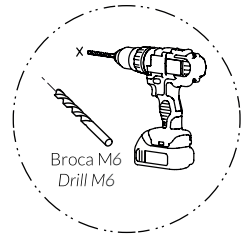
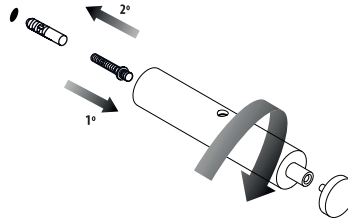

4

Connect the driver using the provided connector.

Conectar el driver a la red, usando la regleta proporcionada.

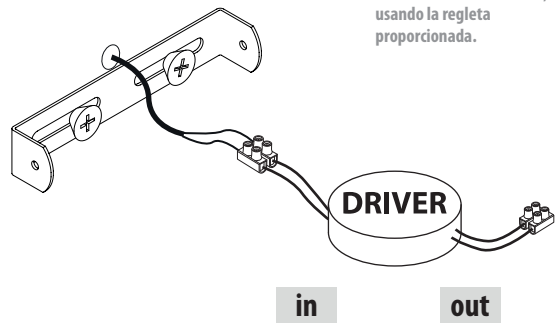

5

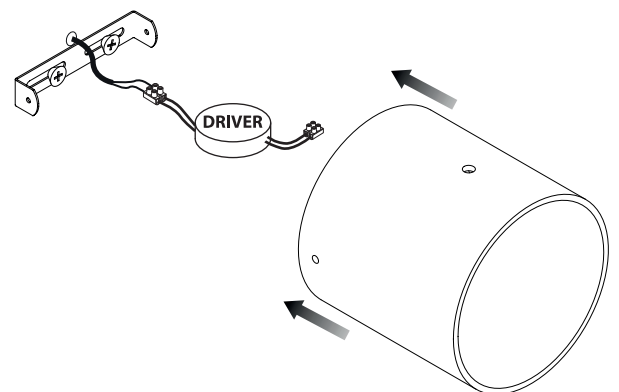

6

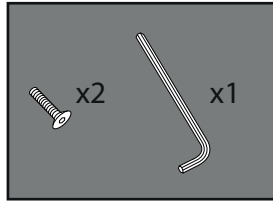
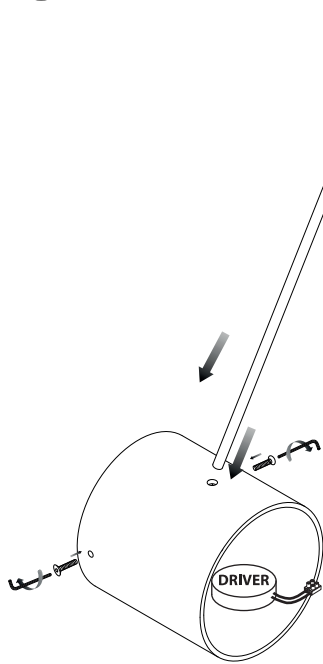

Fix the rosette using the side screws.

Fijar el florón mediante los tornillos laterales.

Insert the threaded tube into the rosette.

Introducir el tubo roscado en el florón.

8

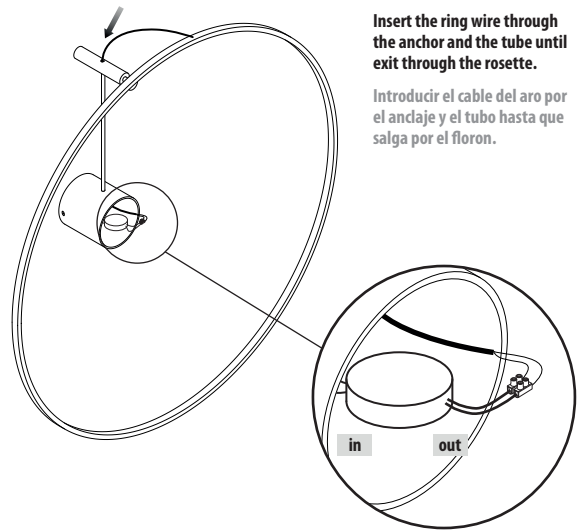

Insert the ring wire through the anchor and the tube until it exits through the rosette.

Introducir el cable del aro por el anclaje y el tubo hasta que salga por el florón.

9

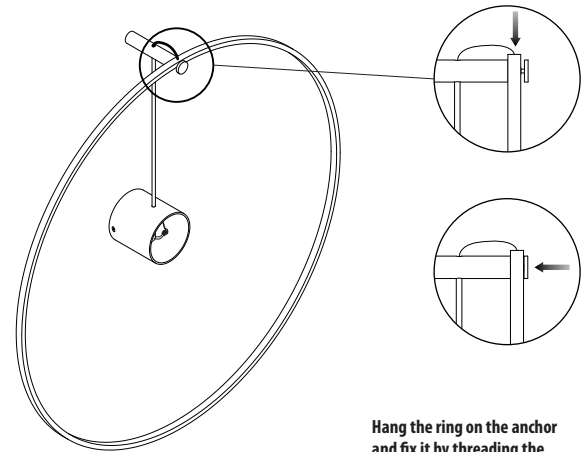

Hang the ring on the anchor and fix it by threading the front trim.

Colgar el aro en el anclaje y fijar roscando el embellecedor delantero.

7

7.a

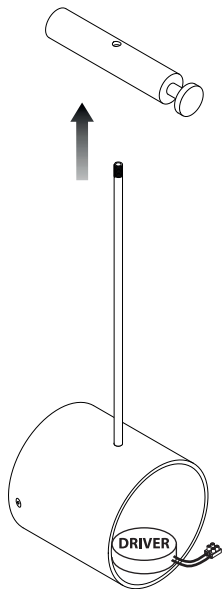

Thread the tube into the anchor, ensuring that it is always inserted into the rosette.

Rosca el tubo en el anclaje asegurando de que quede siempre introducido en el florón.

7.b

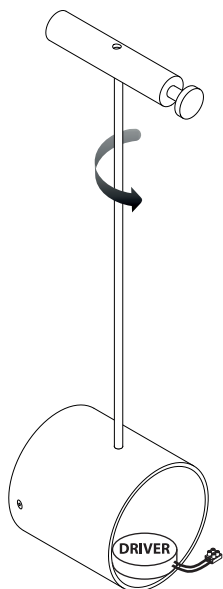

10

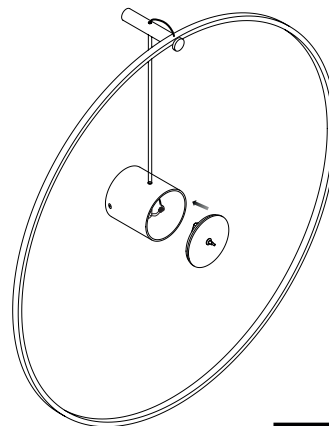

Screw the cover with the mechanism.

Roscar la tapa con el mecanismo.

**REMEMBER!**

Set the battery 1,5V - AA in place.

**RECUERDE!**

Colocar la pila de 1,5V - AA.

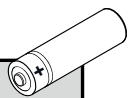

11

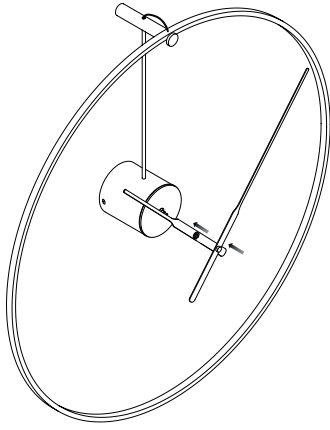

### IMPORTANT!

Pay attention with the correct position of the hands.  
Preste atención con la correcta posición de las agujas.

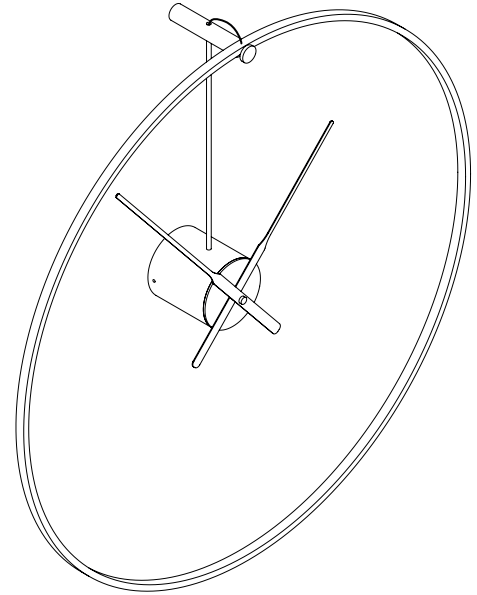
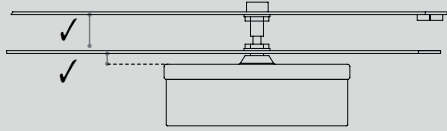

12

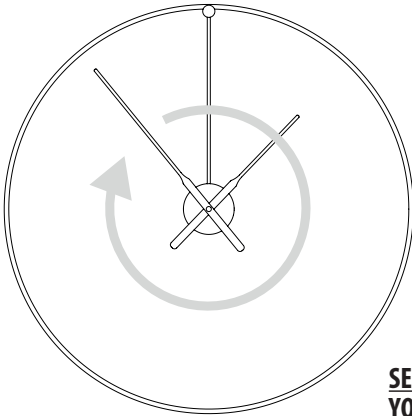

### SET THE TIME ON YOUR CLOCK.

### AJUSTAR LA HORA DEL RELOJ.

Move the minute hand always clockwise until you get the desired time.

Mover la aguja minuterera siempre en sentido horario hasta conseguir la hora deseada.

### CAUTION!

#### NEVER WIND THE HANDS IN THE ANTI-CLOCKWISE DIRECTION.

Wind the minute hand clockwise until both hands are at 12 o'clock. Then, to set the time, continue to wind the minute hand clockwise until the desired time is reached.

### ATENCIÓN!

#### NUNCA GIRAR LAS AGUJAS EN SENTIDO ANTIHORARIO.

Gire cuidadosamente la aguja en el sentido de las agujas del reloj hasta alcanzar las 12:00, continúe girando la aguja minuterera hasta alcanzar la hora deseada.

### WARNING!



- Never cover the luminaire.
- Disconnect power supply before disassemble or manipulation of the clock.
- If the wire or flexible cord is damaged, it must only be change by the manufacturer, their Service Dept. or qualified personnel in order to avoid risk.



Installation of this material can be dangerous and must be done by qualified personnel.

### ATENCIÓN!



- No cubra la luminaria.
- Desconectar la conexión a red antes de ser manipulada.
- Si el cable flexible o cordón de esta luminaria es dañado, deberá sustituirse exclusivamente por el fabricante o su servicio técnico o una persona de cualificación equivalente con objeto de evitar cualquier riesgo.



La instalación de este material podría ser peligroso y por ello se ha de hacer por personal cualificado.

### LIGHT SOURCE ILUMINACIÓN

NOT DIMMABLE  
Lamp: LED  
Input voltage / Frequency: 100 - 240 V / 50 - 60 Hz  
(according to destination)  
Wattage 8 W  
Efficacy: 75Lm/W  
Lumens: 600 lm  
Colour Temperature: 3000K  
Angle: 120°  
CRI: ≥ 90  
IP: IP20

